

# NORM-GAS

BALL VALVES

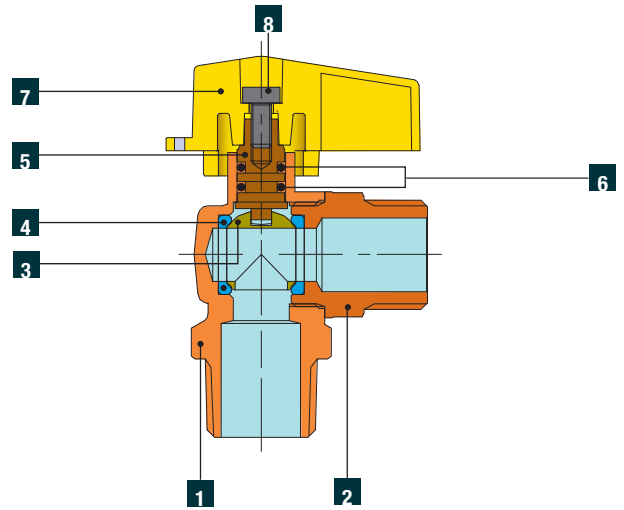

Components	Pcs	Material
<b>1</b> Body	1	UNI EN 12165 CW617N
<b>2</b> End sleeve	1	UNI EN 12165 CW617N
<b>3</b> Ball	1	UNI EN 12165 CW617N UNI EN 12164 CW617N
<b>4</b> Ball seal seats	2	P.T.F.E.
<b>5</b> Stem	1	UNI EN 12164 CW617N
<b>6</b> Stem seal O-Ring	2	NBR 70 Sh A (ASTM D 2240)
<b>7</b> Lever	1	AL painted
<b>8</b> Screw	1	Zinc-plated Steel

**EN GENERAL CHARACTERISTICS**

Bore: Standard  
 Range: 1/2"  
 Body thread: UNI EN 10226 (UNI EN ISO 7/1 Rp and R) (DIN2999)  
 End sleeve thread: Male ISO 228/1 (DIN 259);  
 Female thread: UNI EN 10226 (UNI EN ISO 7/1 Rp) (DIN2999)  
 Functioning: 90° degrees rotation of operating device.  
 Operating device: Aluminium painted lever handle, sealable in closed position.

**OPERATING CONDITIONS**

Flow direction: for the angle valves, from the bottom to the side.  
 Operating Temperature: from -20 °C to +60 °C  
 Operating pressure: MOP 5  
 Valves must be used in fully open or fully closed position.  
 Thread hose end conform UNI-CIG 7141/91 for the connection of non-metallic flexible pipes (UNI-CIG 7140/93).

These valves are suitable for use with the three classes of gases (methane, gas mains, GPL), for low and medium pressure distribution mains and plants; for special uses (in compliance with the pressures set out for these valves) see chemical compatibility chart in the technical annexes of the applicable catalogue. Items included in the CE marking, as per Art. 4 Paragraph 3 of the Directive 2014/68/EU.

GP 2140  
NORM-GAS

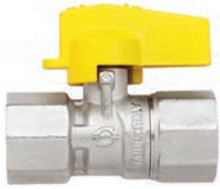

Female-Female straight ball cock, with yellow aluminium lever handle.

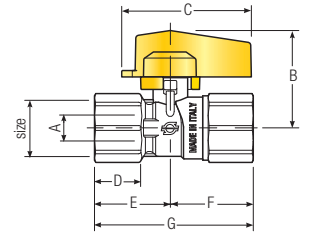

CODE	Size	A mm	B mm	C mm	D mm	E mm	F mm	G mm	gr	Pack pcs/box	Master pcs/box
8100R104	1/2"	10	37,6	48	17	28	30,75	58,75	141	20	160

GP 2140  
NORM-GAS



Male-Female straight ball cock, with yellow aluminium lever handle.

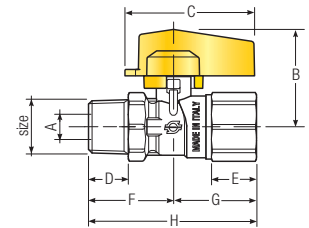

CODE	Size	A mm	B mm	C mm	D mm	E mm	F mm	G mm	H mm	gr	Pack pcs/box	Master pcs/box
8101R104	1/2"	10	37,6	48	14,8	17	31,75	30,75	62,5	143	20	160

GP 2140  
NORM-GAS



Male ISO 7 - Male ISO 228 straight ball cock, with yellow aluminium lever handle.

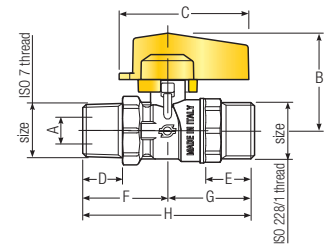

CODE	Size	A mm	B mm	C mm	D mm	E mm	F mm	G mm	H mm	gr	Pack pcs/box	Master pcs/box
8103R076	1/2"	10	37,6	48	14,8	17	31,75	30,75	62,5	143	20	160

GP 2140  
NORM-GAS



Female-Hose holder GAS UNI 7141 straight ball cock, with yellow aluminium lever handle.

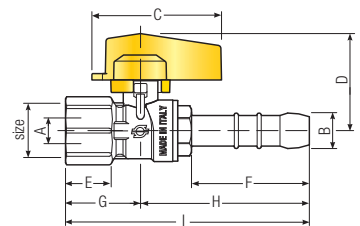

CODE	Size	A mm	B mm	C mm	D mm	E mm	F mm	G mm	H mm	I mm	gr	Pack pcs/box	Master pcs/box
8104R104	1/2"	10	14	48	37,6	17	44	28	63	91	145	20	160

GP 2140  
NORM-GAS



Male-Hose holder GAS UNI 7141 straight ball cock, with yellow aluminium lever handle.

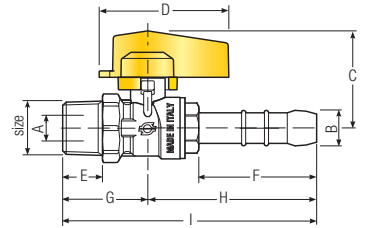

CODE	Size	øA mm	øB mm	C mm	D mm	E mm	F mm	G mm	H mm	I mm	gr	Pack pcs/box	Master pcs/box
8105R104	1/2"	10	14	37,6	48	14,8	44	31,75	63	94,75	148	20	160

GP 2140  
NORM-GAS

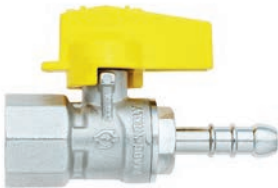

Female-hose holder GPL UNI 7141 straight ball cock, with yellow aluminium lever handle.

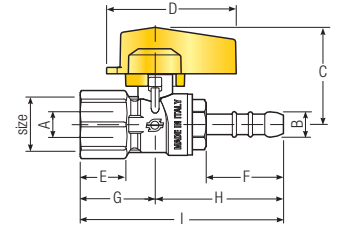

CODE	Size	A mm	B mm	C mm	D mm	E mm	F mm	G mm	H mm	I mm	gr	Pack pcs/box	Master pcs/box
8106R104	1/2"	10	9,8	37,6	48	17	29	28	48	76	131	20	160

GP 2140  
NORM-GAS



Male-Hose holder GPL UNI 7141 straight ball cock, with yellow aluminium lever handle.

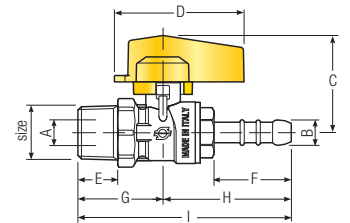

CODE	Size	A mm	B mm	C mm	D mm	E mm	F mm	G mm	H mm	I mm	gr	PN	Pack pcs/box	Master pcs/box
8107R104	1/2"	10	9,8	37,6	48	14,8	29	31,75	48	79,75	136	4	20	160

GP 2140  
NORM-GAS



Female-Female revolving nut straight ball cock, with yellow aluminium lever handle.

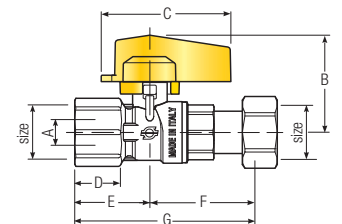

CODE	Size	A mm	B mm	C mm	D mm	E mm	F mm	G mm	gr	Pack pcs/box	Master pcs/box
8108R076	1/2"Fx1/2"D	10	37,6	48	17	28	39	67	167	20	160
8108R077	1/2"Fx3/4"D	10	37,6	48	17	28	39	67	171	20	160

GP 2140  
NORM-GAS



Male-Female revolving nut straight ball cock,  
with yellow aluminium lever handle.

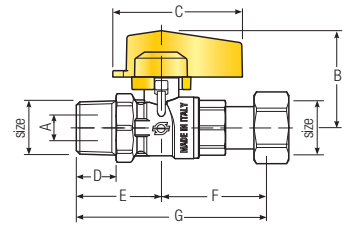

CODE	Size	A mm	B mm	C mm	D mm	E mm	F mm	G mm	gr	Pack pcs/box	Master pcs/box
8109R076	1/2"Mx1/2"D	10	37,6	48	14,8	31,75	39	70,75	171	20	160
8109R077	1/2"Mx3/4"D	10	37,6	48	14,8	31,75	39	70,75	175	20	160

GP 2140  
NORM-GAS



Female-Female ISO 7 angle ball cock, with yellow aluminium lever handle.

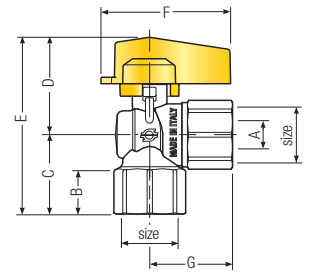

CODE	Size	A mm	B mm	C mm	D mm	E mm	F mm	G mm	gr	Pack pcs/box	Master pcs/box
8110R104	1/2"x1/2"	10	17	31	37,6	68,6	48	30,75	147	20	160

GP 2140  
NORM-GAS



Male-Female ISO 7 angle ball cock, with yellow aluminium lever handle.

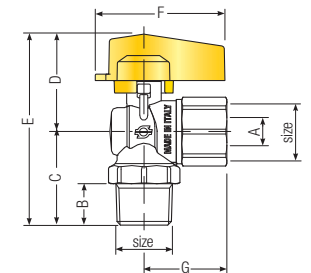

CODE	Size	A mm	B mm	C mm	D mm	E mm	F mm	G mm	gr	Pack pcs/box	Master pcs/box
8111R104	1/2"x1/2"	10	14,8	34,5	37,6	72,1	48	30,75	152	20	160

GP 2140  
NORM-GAS



Female ISO 7-Male ISO 228 angle ball cock, with yellow aluminium lever handle.

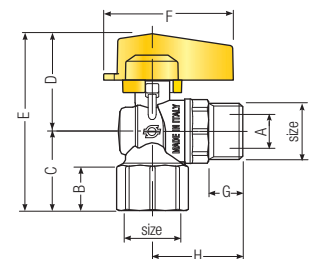

CODE	Size	A mm	B mm	C mm	D mm	E mm	F mm	G mm	H mm	gr	Pack pcs/box	Master pcs/box
8112R076	1/2"x1/2"	10	17	31	37,6	68,6	48	12	31,5	145	20	160

GP 2140  
NORM-GAS



Male ISO 7 - Male ISO 228 angle ball cock,  
with yellow aluminium lever handle.

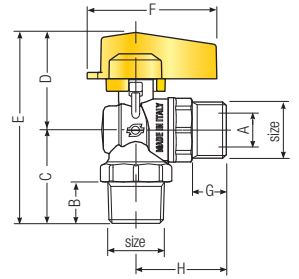

CODE	Size	A mm	B mm	C mm	D mm	E mm	F mm	G mm	H mm	gr	Pack pcs/box	Master pcs/box
8113R076	1/2"x1/2"	10	14,8	34,5	37,6	72,1	48	12	31,5	149	20	160

GP 2140  
NORM-GAS



Female-Hose holder GAS UNI 7141 angle ball cock,  
with yellow aluminium lever handle.

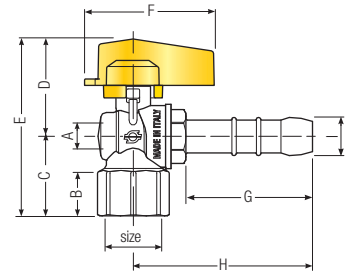

CODE	Size	A mm	B mm	C mm	D mm	E mm	F mm	G mm	H mm	øI mm	gr	Pack pcs/box	Master pcs/box
8114R104	1/2"	10	17	31	37,6	68,6	48	44	63	14	152	20	160

GP 2140  
NORM-GAS



Male-Hose holder GAS UNI 7141 angle ball cock,  
with yellow aluminium lever handle.

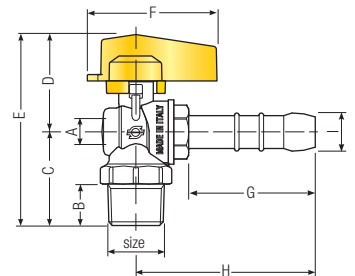

CODE	Size	A mm	B mm	C mm	D mm	E mm	F mm	G mm	H mm	I mm	gr	Pack pcs/box	Master pcs/box
8115R104	1/2"	10	14,8	31	37,6	68,6	48	44	63	14	157	20	160

GP 2140  
NORM-GAS



Female-Hose holder GPL UNI 7141 angle ball cock,  
with yellow aluminium lever handle.

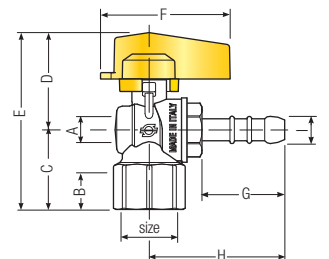

CODE	Size	A mm	B mm	C mm	D mm	E mm	F mm	G mm	H mm	I mm	gr	Pack pcs/box	Master pcs/box
8116R104	1/2"	10	17	31	37,6	68,6	48	29	48	9,8	139	20	160

GP 2140  
NORM-GAS



Male-Hose holder GPL UNI 7141 angle ball cock,  
with yellow aluminium lever handle.

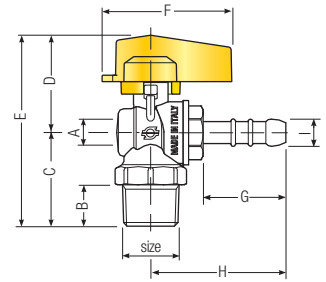

CODE	Size	A mm	B mm	C mm	D mm	E mm	F mm	G mm	H mm	I mm	gr	Pack pcs/box	Master pcs/box
8117R104	1/2"	10	15	35	37,6	72,1	48	29	48	9,8	142	20	160

GP 2140  
NORM-GAS



Female ISO 7-Female revolving nut ISO 228 angle ball cock,  
with yellow aluminium lever handle.

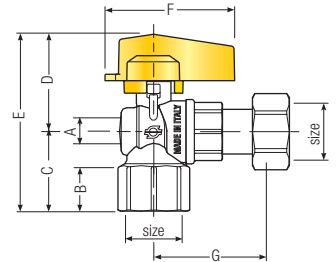

CODE	Size	A mm	B mm	C mm	D mm	E mm	F mm	G mm	gr	Pack pcs/box	Master pcs/box
8118R076	1/2"Fx1/2"D	10	17	31	37,6	68,6	48	39	174	20	160
8118R077	1/2"Fx3/4"D	10	17	31	37,6	68,6	48	39	178	20	160

GP 2140  
NORM-GAS



Male ISO 7-Female revolving nut ISO 228 angle ball cock,  
with yellow aluminium lever handle.

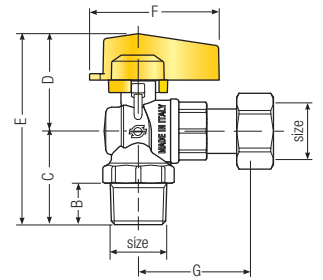

CODE	Size	A mm	B mm	C mm	D mm	E mm	F mm	G mm	gr	Pack pcs/box	Master pcs/box
8119R076	1/2"Mx1/2"D	10	14,8	34,5	37,6	72,1	48	39	177	20	160
8119R077	1/2"Mx3/4"D	10	14,8	34,5	37,6	72,1	48	39	181	20	160